

General Specifications

UT55A, UT52A Digital Indicating Controller (Panel Mounting Type)

UTAdvanced

Functional Enhancement

GS 05P01C31-01EN

Overview

The UT55A and UT52A digital indicating controllers employ an easy-to-read, 14-segment large color LCD display, along with navigation keys, thus greatly increasing the monitoring and operating capabilities. A ladder sequence function is included as standard. The short depth of the controller helps save instrument panel space. The UT55A and UT52A also support open networks such as Ethernet communication.

The UT55A and UT52A have a DIN rail mounting type (with option code /MDL). For more details, please see General Specification GS 05P01C81-01EN.

Features

- A 14-segment, active (PV display color changing function) color LCD display is employed. Two five-digit, high-resolution displays are possible. Alphabet letters can be displayed in an easy-to-read manner. The guide display shows parameter names.
- Easy to operate
Navigation keys (SET/ENTER and Up/Down/Left/Right arrow keys) are employed to facilitate making settings.
- 65 mm depth
The small depth enables the mounting in a thin and small instrumented panel.
- Ladder sequence function is included as standard. This function allows for creating a simple sequence control. Dedicated LL50A Parameter Setting Software (sold separately) allows for performing programming using a ladder language.
- Various built-in open network functions such as Ethernet are available. Easy connection with various vendors' PLCs is possible. (UT52A support CC-Link and RS485 communication only.)
- Quick setting function
Setting only the minimum necessary parameters for operation is possible. (For single-loop control only)
- Equipped with a multitude of functions
Universal I/O, eight control modes (cascade control, etc), and retransmission output are included as standard. PID control, heating/cooling control, feed forward control, etc. are available.
- LL50A Parameter Setting Software (sold separately)
The parameters and ladder programs of UTAdvanced digital indicating controller can be built from a PC using this software. It makes data management even easier.
- Dust-proof and drip-proof
IP66 (for front panel) (Not applicable to side-by-side close mounting.)
NEMA4 (Hose-down test only)

Functional Specifications

Control Specifications

(1) Control Mode

Control functions of the controller can be set as control modes.



Control mode	Function
SGL (1)	Single-loop control
CAS1 (2)	Cascade primary-loop control ^{(*)1}
CAS2 (3)	Cascade secondary-loop control ^{(*)1}
CAS (4)	Cascade control ^{(*)1}
BUM (5)	Loop control for backup ^{(*)1}
PVSW (6)	Loop control with PV switching ^{(*)1}
PVSEL (7)	Loop control with PV auto-selector (Max./Min./Ave./Diff.) ^{(*)1}
PVHD (8)	Control with PV-hold function

*1: Remote auxiliary analog input is required.

2) Control period

Selectable from 50 ms ^{(*)2}, 100 ms, and 200 ms

*2: Cascade control (Control mode 4) cannot be used. "Super" function or "Super 2" function cannot be used.

Table of Number of Inputs and Outputs

Model and suffix code (See the model code)	Number of analog input points	Number of analog output points ^{(*)3}	Number of contact input points ^{(*)4}	Number of contact output points ^{(*)5}
UT55A				
-x0x	1	1	3	3
-x1x	2	1	9 (8)	8
-x2x	2	1	4 (3)	3
-x3x	1	1	8	8
-x4x	2	1	4 (3)	3
-x5x	2	1	9 (8)	8
-x6x	1	1	8	18
-x7x	4	1	6 (5)	3
UT52A				
-x0x	1	1	3	3
-x1x	2	1	3	3
-x2x	2	1	4 (3)	3
-x3x	1	1	5	5

*3: Excluding control output

*4: The numbers in parentheses show the numbers of points in each model with RSP direct input. (/DR option.)

*5: Excluding control output relays

Control Computation Specifications

(1) Combination of types of control and control modes

Types of control	Control mode							
	1	2	3	4	5	6	7	8
PID control	√	√ ⁽⁶⁾	√	√	√	√	√	√
ON/OFF control ⁽⁶⁾	√	N/A	N/A	N/A	N/A	√	√	N/A
Two-position, two-level control ⁽⁷⁾	√	N/A	N/A	N/A	N/A	N/A	N/A	N/A
Heating and cooling control ⁽⁷⁾	√	N/A	√	√	√	√	√	√
Sample PI control	√	N/A	N/A	N/A	N/A	√	√	√
Batch PID control	√	N/A	N/A	N/A	N/A	√	√	√
Feedforward control	√	N/A	N/A	N/A	N/A	N/A	N/A	√

√: Available N/A: Not Available

*6: Not selectable for Position proportional type

*7: Selectable for heating and cooling control

(2) Control Computation Function

(a) Target setting point and the number of PID parameter groups

Respectively, eight sets of target setpoints, alarm setpoints, and PID parameters can be set. For cascade control, respectively, eight sets can be set for main (primary side) and slave (secondary side).

(b) Selecting the PID parameter group

The following PID parameter groups can be selected.

- Target setpoint number (SPNO) (The PID number can be set arbitrarily.)
- Measured input zone PID
- Target setpoint zone PID
- Reached target setpoint zone PID

(c) Auto-tuning

- Tuning results can be selected from two options, Normal or Stable.

- Tuning output limit can be set. (It cannot be used in heating/cooling control.)

(d) "Super" function: Overshoot-suppressing function

(e) "Super 2" function: Hunting-suppressing function

(f) STOP preset output function

(g) Input ERROR preset output function

(h) MANUAL preset output function

(3) Operation Mode Switching

Operation mode switching	AUTO/MANUAL and RUN/STOP switching CASCADE/AUTO/MANUAL switching REMOTE/LOCAL switching
--------------------------	---

(4) Control Parameter Setting Range

Proportional band	0.1 to 999.9%
Integral time	1 to 6000 sec. or OFF (using manual reset)
Derivative time	1 to 6000 sec. or OFF
ON/OFF control hysteresis (one or two hysteresis points)	0.0 to 100.0% of measured input range width
Preset output value	-5.0 to 105.0% (however, 0 mA or less cannot be output)
High/low output limiter	-5.0 to 105.0% Low limit setpoint < high limit setpoint
Tight shut function	When manual control is carried out with 4 to 20 mA output, control output can be reduced to about 0 mA.
Rate-of-change limiter of output	0.1 to 100.0%/sec., OFF
Output deadband	For heating and cooling control: -100.0 to 50.0% For position proportional control: 1.0 to 10.0%

(5) Ladder computation period

Ladder computation period is the same as control period.

Alarm Functions

• Types of Alarm

Measured value alarm	PV (measured value) high/low limit alarm Deviation high/low limit alarm
Deviation alarm	Deviation high and low limits alarm Deviation within high and low limits alarm
Rate-of-change alarm	Analog input PV high/low limit alarm Analog input RSP (ROMOTE) SP high/low limit alarm Auxiliary analog input high/low limit alarm Feedback input high/low limit alarm PV rate-of-change alarm
Setpoint alarm	SP (setpoint) high/low limit alarm Target SP high/low limit alarm Target SP deviation high/low limit alarm Target SP deviation high and low limits alarm Target SP deviation within high and low limits alarm
Output alarm	Control output high/low limit alarm Cooling control output high/low limit alarm
Other alarms	Heater disconnection alarm (for /HA option) Self-diagnosis alarm FAIL

• Alarm Functions

Alarm output action	Alarm stand-by action Alarm latch (forced reset) function Alarm hysteresis Alarm ON/OFF delay timer
Number of alarm settings	8 (per loop)
Number of alarm output points	Up to 18 (differs by model code)

Contact I/O Function

This function allows for allocating the input error condition, operation condition, alarm condition or other conditions to the contact input and contact output.

Contact input	AUTO/MANUAL switching
	REMOTE/LOCAL switching
	STOP/START switching
	Switching to CASCADE
	Switching to AUTO
	Switching to MANUAL
	Switching to REMOTE
	Switching to LOCAL
	AUTO-TUNING START/STOP switching
	OUTPUT TRACKING switching
	Two-input switching
	PV Hold
	LCD backlight ON/OFF switching
Message interrupt displays 1 through 4	
SP number specification	
PID number specification	
Manual preset output number specification	
Contact output	Loop 1 alarms 1 through 8
	Loop 2 alarms 1 through 8 (for cascade control)
	Status output

Ladder Sequence Function

(1) Number of I/O Points

	UT55A	UT52A
Number of digital input points	Up to 9	Up to 5
Number of digital output points	Up to 18	Up to 5

This is limited by the number of contact I/O signal points. (See the model code.)

(2) Types of Command

	Number of commands	Remark
Number of basic command types	13	Load, AND, OR, Timer, Counter, etc.
Number of application command types	73	Comparison, reverse, addition/subtraction/multiplication/division, logic operation, high/low limiter, etc.

(4) Program capacity

Max. Program capacity: 500 steps *

*: Available number of steps differs according to the parameters, using command and control period.

(5) Ladder computation period

Ladder computation period is the same as control period.

(3) Sequence Device

	Types of device	Number of points
Digital I/O	Input relay	9 (max)
	Output relay	18 (max)
Internal device	M relay (bit data)	256
	DAT register (data)	28
	P register (parameter)	10
	K register (constant)	30
Special device	Special relay (bit data)	12

* Process data and process relay can be used besides the above-mentioned.

Communication Function

	Function	Method	Interface	Targets	Max connection	Communication Data
Modbus/TCP	A standard industry protocol allowing communications between the controller and devices such as PCs, PLCs, and DCSs.	Server	Ethernet	PLC and others	2 connections	PV, SP, OUT, ALM etc
		Gateway	Ethernet +RS-485	RS-485: UT75A, UT55A, UT52A, UT35A, UT32A, UP55A, UP35A, UM33A ^(*)	31 units	
Modbus (RTU/ASCII)	Slave	RS-485	PLC and others, UT75A, UT55A, UT52A, UT35A, UT32A, UP55A, UP35A, UP32A, UM33A ^(*)	31 units		
PROFIBUS-DP	Used for communication between PLCs and remote I/O, enabling high-speed data transmission.	Slave	RS-485	PLC and others	Number of nodes: 126	
		Modbus master function	RS-485	UT75A, UT55A, UT52A, UT35A, UT32A, UP55A, UP35A	31 Units (Main Controller is included.)	
CC-Link	Used for communication between PLCs and remote I/O, enabling high-speed data transmission.	Slave	RS-485	PLC and others	Number of nodes: 42 (Remote device)	
		Modbus master function	RS-485	UT75A, UT55A, UT52A, UT35A, UT32A, UP55A, UP35A, UP32A, UM33A	31 Units (Main Controller is included.)	
DeviceNet	A protocol allowing multiple controllers to send and receive data between one another. The Ladder Program is used.	Slave	RS-485	PLC and others	Number of nodes: 64	
		Modbus master function	RS-485	UT75A, UT55A, UT52A, UT35A, UT32A, UP55A, UP35A	31 Units (Main Controller is included.)	
Peer to peer	A protocol to coordinate the operation of two or more instruments controlling the same process.	Multi-drop	RS-485 (2 wire only)	UT75A, UT55A, UT52A, UT35A, UT32A, UP55A, UP35A, UP32A	Read/Write: 4 units Read only : 28 units	
Coordinated Communication	The proprietary Yokogawa protocol allowing communications to PCs, PLCs and touch panels.	Master/Slave	RS-485	UT75A, UT55A, UT52A, UT35A, UT32A, UP55A, UP35A, UP32A ^(*)	Master : 1 unit Slave : 31 units	
PC link	A protocol to communicate to PLCs.	Slave	RS-485	PC and others, UT75A, UT55A, UT52A, UT35A, UT32A, UP55A, UP35A, UP32A, UM33A ^(*)	31units	
Ladder						

*1: UT digital indicating controller, Signal conditioner JUXTA, Power monitor POWERCERT can be connected.

*2: UT digital indication controllers can be connected.

■ Hardware Specifications

Display Specifications

- PV display
5-digit, 14-segment active color LCD (white/red)
Character height: 21.5 mm for UT55A and 13.0 mm for UT52A
- Data display
5-digit, 11-segment color LCD (orange)
- Bar graph display
12-segment color LCD (orange and white)

Universal Input Specifications

- Number of input points: 1
- Types of input, instrument range, and measurement accuracy (see the table below)

Types of input	Instrument range		Accuracy	
	°C	°F		
Thermocouple	K	-270.0 to 1370.0°C	-450.0 to 2500.0°F	±0.1% of instrument range ±1 digit for 0°C or more
		-270.0 to 1000.0°C	-450.0 to 2300.0°F	
		-200.0 to 500.0°C	-200.0 to 1000.0°F	
	J	-200.0 to 1200.0°C	-300.0 to 2300.0°F	±0.2% of instrument range ±1 digit for less than 0°C
		-270.0 to 400.0°C	-450.0 to 750.0°F	
	T	0.0 to 400.0°C	-200.0 to 750.0°F	±0.15% of instrument range ±1 digit for less than -200°C of thermocouple K ±1% of instrument range ±1 digit for less than -200°C of thermocouple T
	B	0.0 to 1800.0°C	32 to 3300°F	±0.15% of instrument range ±1 digit for 400°C or more ±5% of instrument range ±1 digit for less than 400°C
	S	0.0 to 1700.0°C	32 to 3100°F	±0.15% of instrument range ±1 digit
	R	0.0 to 1700.0°C	32 to 3100°F	
	N	-200.0 to 1300.0°C	-300.0 to 2400.0°F	±0.1% of instrument range ±1 digit ±0.25% of instrument range ±1 digit for less than 0°C
	E	-270.0 to 1000.0°C	-450.0 to 1800.0°F	±0.1% of instrument range ±1 digit for 0°C or more ±0.2% of instrument range ±1 digit for less than 0°C
	L	-200.0 to 900.0°C	-300.0 to 1600.0°F	
	U	-200.0 to 400.0°C	-300.0 to 750.0°F	
	W ⁽²⁾	0.0 to 2300.0°C	32 to 4200°F	±0.2% of instrument range ±1 digit
	Platinel 2	0.0 to 1390.0°C	32.0 to 2500.0°F	±0.1% of instrument range ±1 digit
	PR20-40	0.0 to 1900.0°C	32 to 3400°F	±0.5% of instrument range ±1 digit for 800°C or more Accuracy not guaranteed for less than 800°C
	W97 Re3-W75 Re25	0.0 to 2000.0°C	32 to 3600°F	±0.2% of instrument range ±1 digit
Resistance-temperature detector (RTD) 3-wire	JPt100	-200.0 to 500.0°C	-300.0 to 1000.0°F	±0.1% of instrument range ±1 digit ⁽¹⁾
		-150.00 to 150.00°C	-200.0 to 300.0°F	
	Pt100	-200.0 to 850.0°C	-300.0 to 1560.0°F	±0.1% of instrument range ±1 digit ⁽¹⁾
		-200.0 to 500.0°C	-300.0 to 1000.0°F	±0.1% of instrument range ±1 digit
Standard signal	0.400 to 2.0000 V	-	-	±0.1% of instrument range ±1 digit
	1.000 to 5.000 V	-	-	
DC voltage	4.00 to 20.00 mA	-	-	±0.1% of instrument range ±1 digit
	0.000 to 2.000 V	-	-	
	0.00 to 10.00 V	-	-	
DC current	-10.00 to 20.00 mV	-	-	±0.1% of instrument range ±1 digit
	0.00 to 20.00 mA	-	-	

The accuracy is that in the standard operating conditions: 23 ±2°C, 55 ±10%RH, and power frequency at 50/60 Hz.

- *1: ±0.3°C and ±1 digit in the range between 0 and 100°C
±0.5°C ±1 digit in the range between -100 and 200°C
- *2: W-5% Re/W-26% Re (Hoskins Mfg.Co.), ASTM E988
- Applicable standards: JIS, IEC and DIN (ITS-90) for thermocouples and resistance-temperature detectors (RTD)
- Input sampling period: Synchronized to control period
- Burnout detection
Upscale and downscale of function, and OFF can be specified for the standard signal of thermocouple and resistance-temperature detector (RTD).
For integrated signal input, 0.1 V or 0.4 mA or less is judged as a burnout.
- Input bias current: 0.05 μA (for thermocouple and resistance-temperature detector (RTD))
- Resistance-temperature detector (RTD) measured current: About 0.16 mA
- Input resistance
1 MΩ or more for thermocouple/mV input
About 1 MΩ for voltage input
About 250 Ω for current input (with built-in shunt resistance)
- Allowable signal source resistance
250 Ω or less for thermocouple/mV input
Effect of signal source resistance: 0.1 μV/Ω or less
2 kΩ or less for DC voltage input
Effect of signal source resistance: about 0.01%/100 Ω
- Allowable wiring resistance
Up to 150 Ω per line for resistance-temperature detector (RTD) input (conductor resistance between the three lines shall be equal)
Effect of wiring resistance: ±0.1°C/10 Ω
- Allowable input voltage/current
±10 V DC for thermocouple/mV/mA or resistance-temperature detector (RTD) input
±20 V DC for V input
±40 mA DC for mA input
- Noise reduction ratio
40 dB or more (at 50/60 Hz) in normal mode
120 dB or more (at 50/60 Hz) in common mode
- Reference junction compensation error
±1.0°C (15 to 35°C)
±1.5°C (-10 to 5°C and 35 to 50°C)

Auxiliary Analog Input Specifications

- This function can be used for remote setpoint setting, external compensating input, auxiliary input for computation, etc.
- Number of input points: see the model code table.
- For types of input, instrument range, and measurement accuracy, see the table below.

Types of input	Instrument range	Accuracy
Integrated signal	0.400 to 2.000 V	±0.2% of instrument range ±1 digit
	1.000 to 5.000 V	±0.1% of instrument range ±1 digit
DC voltage	0.000 to 2.000 V	±0.2% of instrument range ±1 digit
	0.00 to 10.00 V	±0.1% of instrument range ±1 digit
DC voltage with High input impedance	0.000 to 1.250 V	±0.1% of instrument range ±1 digit

- Input sampling period: Synchronized to control period
- Input resistance: about 1 MΩ
However, 10 MΩ or more for high input impedance
- Burnout detection: Functions at standard signal
Burnout is determined to have occurred if it is 0.1 V or less.

Remote Input with Direct Input Specifications (for /DR Option)

(3-wire or 4-wire when RTD is selected)

- Number of input points: 1 point
- Types of input, instrument range, and measurement accuracy are the same as those of universal input (standard), except for the table below.

Types of input		Instrument range		Accuracy
		°C	°F	
4-wire RTD	JPT100	-200.0 to 500.0°C	-300.0 to 1000.0°F	±0.5°C ±1 digit
		-150.00 to 150.00°C	-200.0 to 300.0°F	±0.2°C ±1 digit
	Pt100	-200.0 to 850.0°C	-300.0 to 1560.0°F	±0.1% of instrument range ±1 digit (*)
		-200.0 to 500.0°C	-300.0 to 1000.0°F	±0.5°C ±1 digit
		-150.00 to 150.00°C	-200.0 to 300.0°F	±0.2°C ±1 digit

*: ±0.5 °C ±1 digit in the range of -200.0 to 500.0 °C

- Input sampling period: Synchronized to control period
- Burnout detection: Same as universal input

Contact Input Specifications

- Number of points: 3 points (standard)
For the maximum number of points, see the model and suffix code table.
- Input type: no-voltage contact input or transistor contact input
- Input contact capacity: 12 V DC, 10 mA or more
Be sure to use a contact with a minimum ON current of 1 mA or less
- ON/OFF detection
For no-voltage contact input:
Contact resistance 1 kΩ or less in ON state
Contact resistance 50 kΩ or more in OFF state
Transistor contact input:
2 V or less in ON state
Leak current 100 μA or less in OFF state
- Status detection minimum hold time: control period + 50 ms
- Application: SP switching, operation mode switching, event input

Analog Output Specifications

- Number of points
Control output (heating-side output): 1 point (standard), which is shared with transmission output
Cooling-side output: 1 point, which is shared with transmission output
- Output functions
Current output or voltage pulse output
- Current output
4 to 20 mA DC or 0 to 20 mA DC/load resistance 600 Ω or less
- Current output accuracy
±0.1% of span (however, ±5% of span for 1 mA or less)
The accuracy is that in the standard operating conditions: 23 ±2°C, 55 ±10%RH, and power frequency at 50/60 Hz
- Voltage pulse output
Application: time proportional output
ON voltage: 12 V or more/load resistance of 600 Ω or more
OFF voltage: 0.1 V DC or less
Time resolution: 10 ms or 0.1% of output value, whichever is larger

Retransmission Output Specifications

- Number of points: 1 point (standard), which is shared with 15 V DC loop power supply
Additional 2 points when analog control output and cooling-side analog control output are not used
- Output function: current output
4 to 20 mA DC or 0 to 20 mA DC/load resistance 600 Ω or less
- Current output accuracy (conversion accuracy from PV display on the set scale): ±0.1% of span (however, ±5% of span for 1 mA or less)
The accuracy is that in the basic operating conditions: 23 ±2°C, 55 ±10%RH, and power frequency at 50/60 Hz
This is not conversion accuracy through input and output but the performance of transmission output itself.

15V DC Loop Power Supply Specifications

- Number of points: 1 point (standard), which is shared with retransmission output
Control output (1 point) can also be used.
- Supply voltage: 14.5 to 18.0 V DC
- Maximum supply current: about 21 mA (with short-circuit current limiting circuit)

Step Response Time Specifications

Within 500 ms (for a control period of 50 ms or 100 ms)
Within 1 s (for a control period of 200 ms)

(Response time at 63% of transmission output when a change is made stepwise in the range between 10 and 90% of input span)

Relay Contact Output Specifications

- Types of contact and number of points
Control relay output: one 1c-contact point
Cooling output of heating and cooling control:
one 1c-contact point (For UT55A only)
For UT52A heating/cooling output:
2 1a-contact points
Alarm output: 3 1a-contact points (Common is separated)
- Contact rating
1c-contact: 3 A at 250 V AC or 3 A at 30 V DC (resistance load)
1a-contact:
For alarm output: 1 A at 240 V AC or 1 A at 30 V DC (resistance load)
For UT52A control relay output: 3 A at 240 V AC or 3 A at 30 V DC (resistance load)
- *: The control output should always be used with a load of 10 mA or more.
The alarm output should always be used with a load of 1 mA or more.
- Application: time proportional output, alarm output, FAIL output, etc.
- Time resolution for control output: 10 ms or 0.1% of output value, whichever is larger

Transistor Contact Output Specifications

- Number of points: see the model and suffix code table
- Output form: open collector (sink current)
- Output contact capacity: Up to 24 V DC, 50 mA
- Output time resolution: min 50 ms
- Application: alarm output, FAIL output, etc.

Position Proportional Output Specifications

- Position signal input
 - Slide resistance: 100 Ω to 2.5 k Ω of total resistance
 - 100% side and slide line: with disconnection detection
 - 0% side: without disconnection detection
 - Current input: 4 to 20 mA DC (with disconnection detection)
 - Input resistance: about 330 Ω
- Sampling period: 50 ms
- Measurement resolution: 0.1% of input span
- Position proportional relay output
 - UT55A: Two 1a-contact points, 3 A at 250 V AC or 3A at 30 V DC (resistance load)
 - UT52A: Two 1a-contact points, 3 A at 240 V AC or 3A at 30 V DC (resistance load)

*: This should always be used with a load of 10 mA or more.

Heater Break Alarm Specifications (for /HA Option)

- Function: Measures the heater current using an external current transformer (CT) and generates a heater break alarm when the measured value is less than the disconnection detection value.
- Number of input points: 2 points
- Number of output points: 2 points (transistor contract output)
- CT input resistance: about 9.4 Ω
- CT input range: 0.0 to 0.1 Arms (0.12 Arms or more cannot be applied)
- Heater current alarm setting range: OFF, 0.1 to 300.0 Arms
- Heater current measured value display range: 0.0 to 360.0 Arms
 - *: The CT ratio can be set. CT ratio setting range: 1 to 3300
- Recommended CT: CT from URD Co. Ltd.
 - CTL-6-S-H: CT ratio 800, measurable current range: 0.1 to 80.0 Arms
 - CTL-12L-30: CT ratio 3000, measurable current range: 0.1 to 180.0 Arms
- Heater current measurement period: 200 ms
- Heater current measurement accuracy: $\pm 5\%$ of CT input range span ± 1 digit (CT error is not included)
- Heater current detection resolution: Within 1/250 of CT input range span
- Disconnection detection ON time: Minimum 200 ms. (for time proportional output)

24 V DC Loop Power Supply Specifications (for /LP Option)

- Application: Power is supplied to the 2-wire transmitter.
- Supply voltage: 21.6 to 28.0 V DC
- Rated current: 4 to 20 mA DC
- Maximum supply current: About 30 mA (with short-circuit current limiting circuit)

Safety and EMC Standards

- Safety:
 - Compliant with IEC/EN 61010-1 (CE), IEC/EN 61010-2-201 (CE), IEC/EN 61010-2-030 (CE), approved by CAN/CSA C22.2 No. 61010-1 (CSA), approved by UL 61010-1.
 - Installation category: II
 - Pollution degree: 2
 - Measurement category: I (CAT I) (UL, CSA)
O (Other) (CE)
 - Rated measurement input voltage: Max. 10 V DC
 - Rated transient overvoltage: 1500 V (*)
 - *: This is a reference safety standard value for measurement category I of CSA/UL 61010-1, and for measurement category O of IEC/EN 61010-2-030. This value is not necessarily a guarantee of instrument performance.
- EMC standards:
 - Compliant with CE marking
 - EN 61326-1 Class A, Table 2 (For use in industrial locations),
 - EN 61326-2-3
 - *: The instrument continues to operate at a measurement accuracy of within $\pm 20\%$ of the range during testing.
 - EN 55011 Class A, Group 1
 - EN 61000-3-2 Class A
 - EN 61000-3-3
 - EMC Regulatory Arrangement in Australia and New Zealand
 - EN 55011 Class A, Group 1
 - KC marking: Electromagnetic wave interference prevention standard, electromagnetic wave protection standard compliance

Power Supply Specifications and Isolation

- Power supply
 - Rated voltage: 100 to 240 V AC (+10%/-15%), 50/60 Hz
 - 24 V AC/DC (+10%/-15%) (When the /DC option is specified)
- Power consumption: UT55A: 18 VA (For the /DC option. DC: 9 VA, AC: 14 VA)
UT52A: 15 VA (For the /DC option. DC: 7 VA, AC: 11 VA)
- Storage: Nonvolatile memory
- Allowable power interruption time: 20 ms (at 100 V AC)
- Withstanding voltage
 - 2300 V AC for 1 minute between primary and secondary terminals (UL, CSA)
 - 3000 V AC for 1 minute between primary and secondary terminals (CE)
 - 1500 V AC for 1 minute between primary terminals
 - 500 V AC for 1 minute between secondary terminals (Primary terminals = Power (*) and relay output terminals, Secondary terminals = Analog I/O signal terminals, contact input terminals, communication terminals, and functional grounding terminals.)
 - *: Power terminals for 24 V AC/DC models are the secondary terminals.
- Insulation resistance
 - Between power supply terminals and a grounding terminal: 20 M Ω or more at 500 V DC

• Isolation specifications

PV (universal) input terminal	Internal circuits	Power supply
Remote (universal) input terminals with direct input / Remote input terminals		
Aux. analog (AIN2) input terminals		
Aux. analog (AIN4) input terminals		
Control and transmission (analog) output terminal (not isolated between the analog output terminals) Valve position (feedback) input terminal		
Control relay (c-contact) output terminal		
Alarm-1 relay (a-contact) output terminal		
Alarm-2 relay (a-contact) output terminal		
Alarm-3 relay (a-contact) output terminal		
Position proportional relay output terminal		
Contact input terminal (All) RS485 communication terminal (2 ports)		
24 V DC loop power supply terminal		
Contact output (transistor) terminal		
Ethernet/PROFIBUS-DP/CC-Link/DeviceNet communication terminal		
Current transformer input terminal		

The circuits divided by lines are insulated mutually.

Environmental Conditions

Normal operating conditions

- Ambient temperature: -10 to 50°C (side-by-side mounting: -10 to 40 °C)
If the CC-Link option is specified, 0 to 50 °C for UT55A, 0 to 40 °C for UT52A. (side-by-side mounting: 0 to 40 °C for UT55A and UT52A with CC-Link option)
- Ambient humidity: 20 to 90% RH (no condensation)
- Magnetic field: 400 A/m or less
- Continuous vibration (at 5 to 9 Hz) Half amplitude of 1.5 mm or less
(at 9 to 150 Hz) 4.9 m/s² or less, 1 oct/min for 90 minutes each in the three axis directions
- Rapid vibration: 14.7 m/s², 15 s or less
- Impact: 98 m/s² or less, 11 msec.
- Installation altitude: 2,000 m or less above sea level
- Warm-up time: 30 minutes or more after the power is turned on
- Start-up time within 10 s

Transportation and Storage Conditions

- Temperature: -25 to 70°C
- Temperature change rate: 20°C per hour or less
- Humidity: 5 to 95%RH (no condensation)

Effects of Operating Conditions

- Effect of ambient temperature
For voltage or TC input:
±1 μV/°C or ±0.01% of F.S. (instrument range)/°C, whichever is greater
For RTD input:
±0.05°C/°C (ambient temperature) or less
For current input:
±0.01% of F.S. (instrument range)/°C
For analog output:
±0.02% of F.S./°C or less
- Effect of power supply fluctuation:
For analog input: ±0.05% of F.S. (instrument range) or less
For analog output: ±0.05% of F.S. or less
(Each within rated voltage range)

■ Block Diagram

Single Loop Control (For the block diagrams of other control modes, see the user's manual)

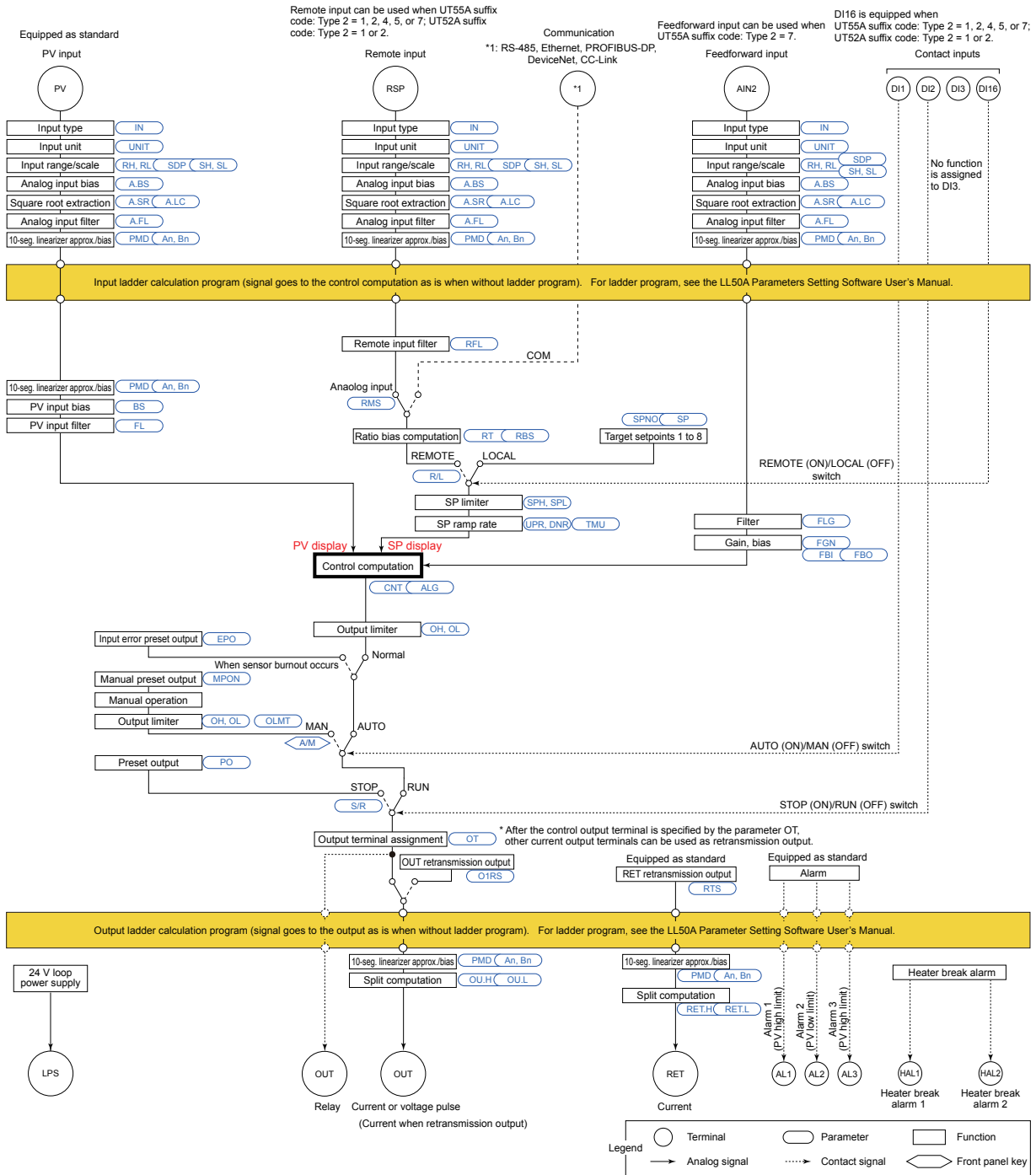

Terminal Arrangement

Terminal Arrangement for UT55A Single Loop Control (for the terminal arrangements of other control modes, see the user's manual.)

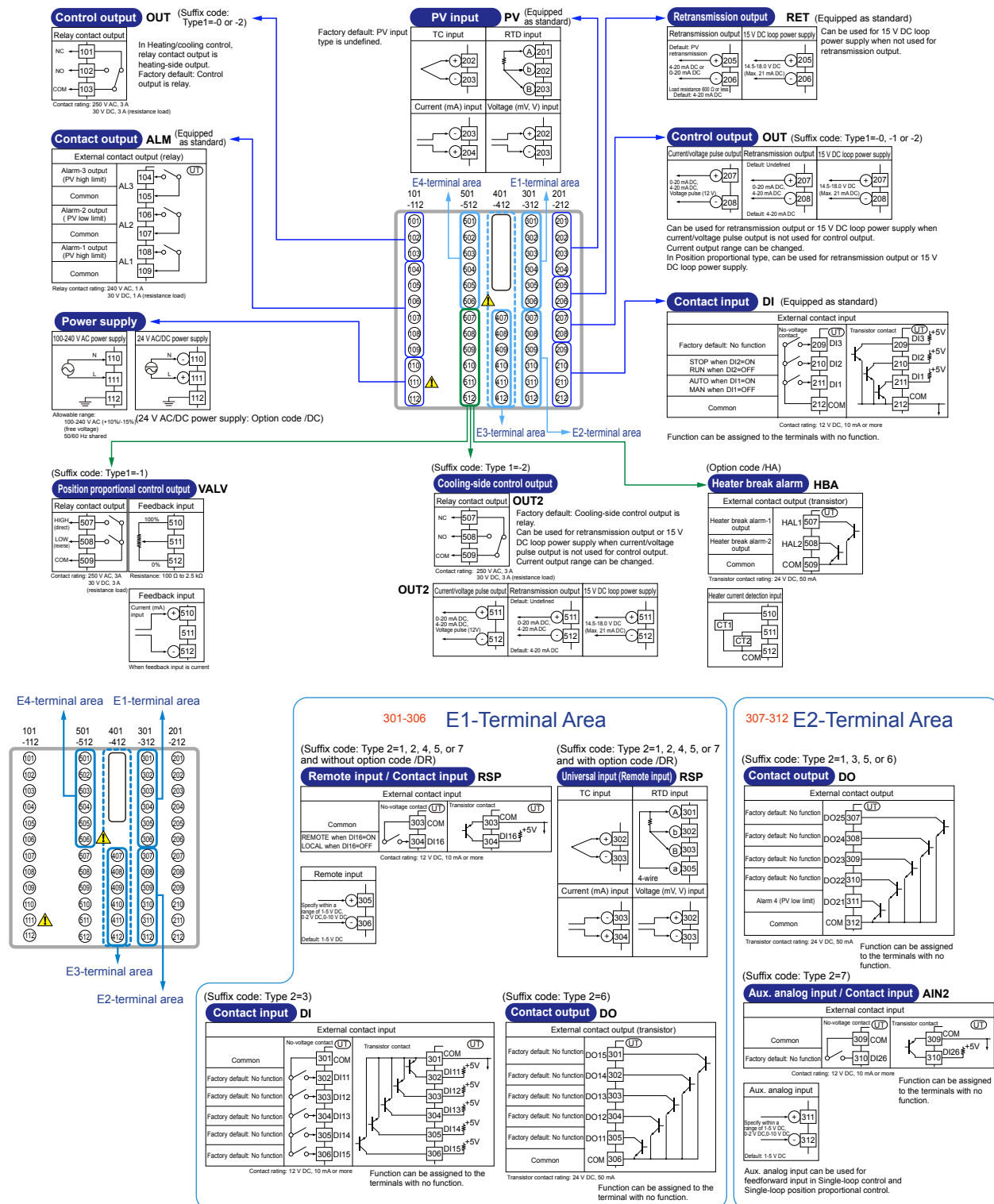

401-412 E3-Terminal Area

Contact input DI (Suffix code: Type 2=1)

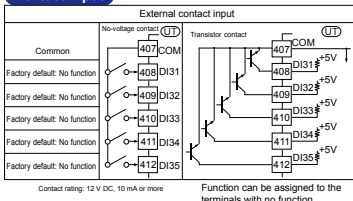

Contact rating: 12 V DC, 10 mA or more
Function can be assigned to the terminals with no function.

Contact output DO (Suffix code: Type 2=6)

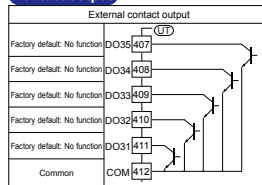

Transistor contact rating: 24 V DC, 50 mA
Function can be assigned to the terminals with no function.

(Suffix code: Type 3=1, except Type 2= 1 or 6)

RS-485 communication

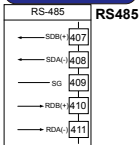

PROFIBUS-DP communication (with Modbus master)

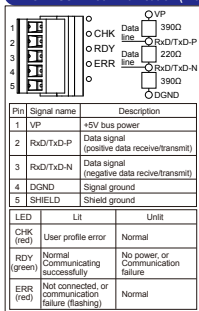

PROF (Suffix code: Type 3=4, except Type 2= 1 or 6)

If the UT is located at the end of a segment for the PROFIBUS communication wiring, terminating resistors are separately needed. These are to be prepared by users. (390 Ω, 2 pcs, 220 Ω, 1 pc, or an active terminator.)

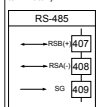

(Suffix code: Type 3=2, except Type 2= 1 or 6)

Ethernet communication (with gateway function)

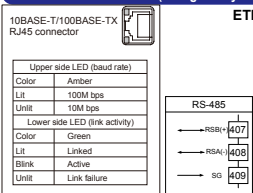

CC-Link communication (with Modbus master)

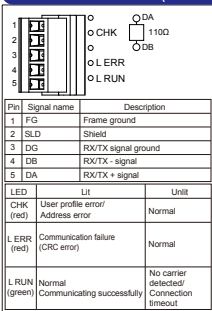

CC-L (Suffix code: Type 3=3, except Type 2= 1 or 6)

If the UT is located at the end of a segment for the CC-Link communication wiring, terminating resistors are separately needed. These are to be prepared by users. (110 Ω, 1 pc.)

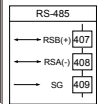

DeviceNet communication (with Modbus master)

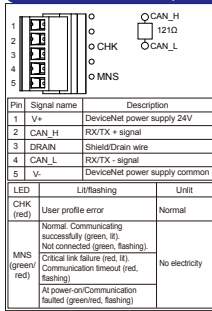

DNET (Suffix code: Type 3=5, except Type 2=1 or 6)

If the UP is located at the end of a segment for the DeviceNet communication wiring, terminating resistors are separately needed. These are to be prepared by users. (121 Ω, 1 pc.)

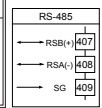

501-506 E4-Terminal Area

RS-485 communication

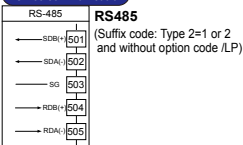

RS-485 communication/24 V DC loop power supply

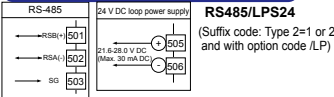

Contact input DI (Suffix code: Type 2=5 or 6)

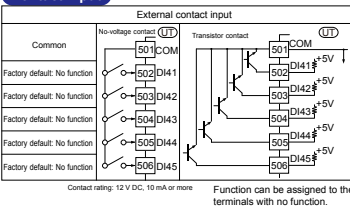

Contact rating: 12 V DC, 10 mA or more
Function can be assigned to the terminals with no function.

(Suffix code: Type 2=7)

Aux. analog input/Contact input AIN4

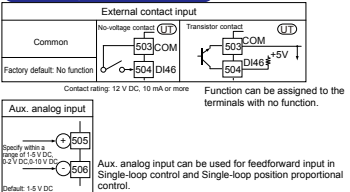

24 V DC loop power supply

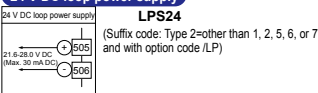

Terminal Arrangement for UT52A Single Loop Control (for the terminal arrangements of other control modes, see the user's manual.)

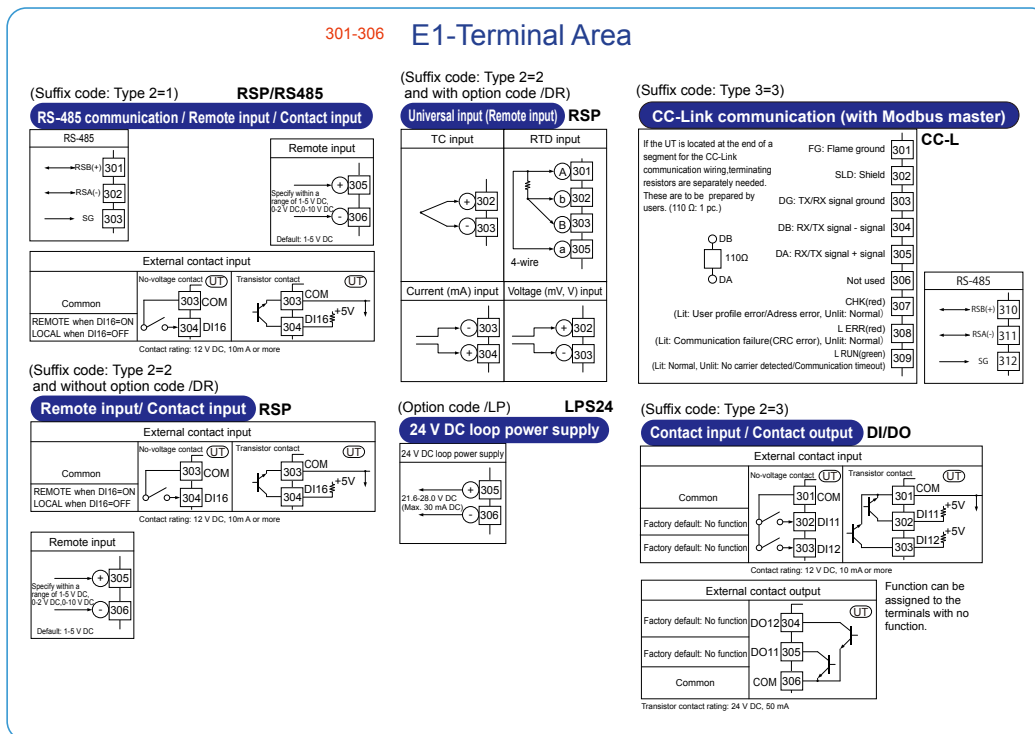
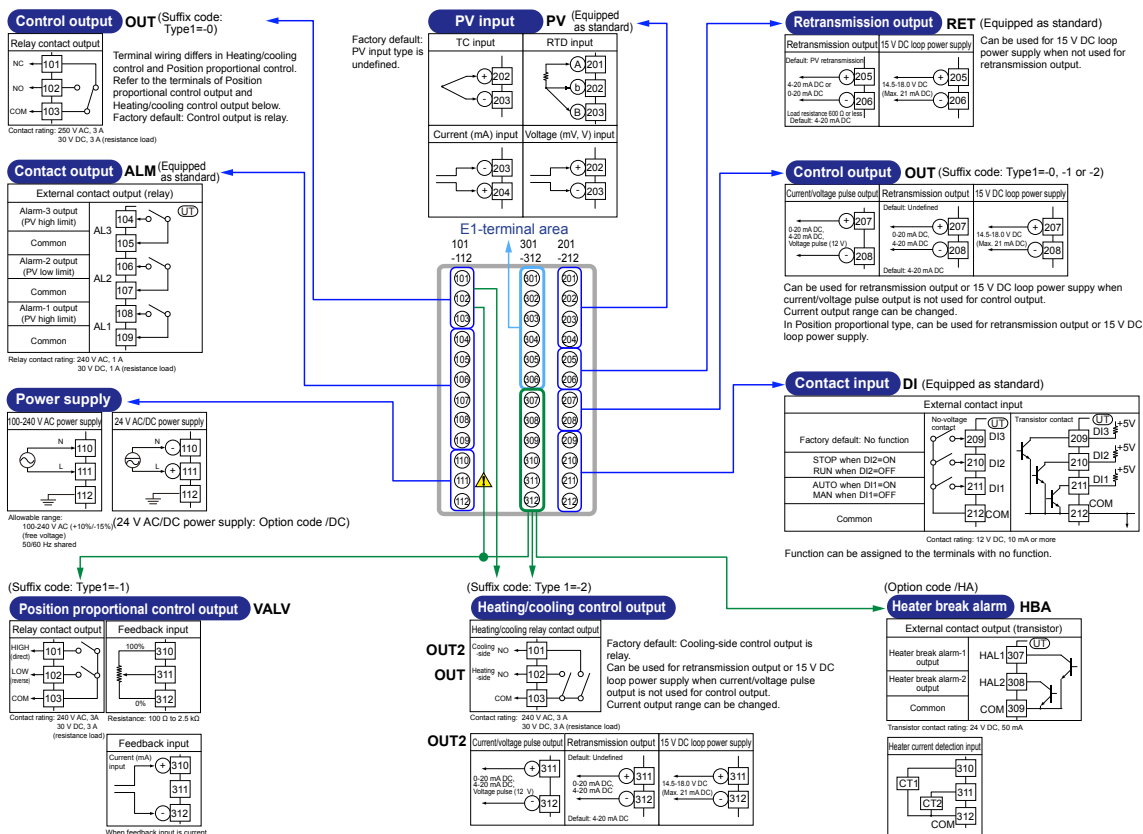

External Dimensions and Panel Cutout Dimensions

UT55A

Unit: mm

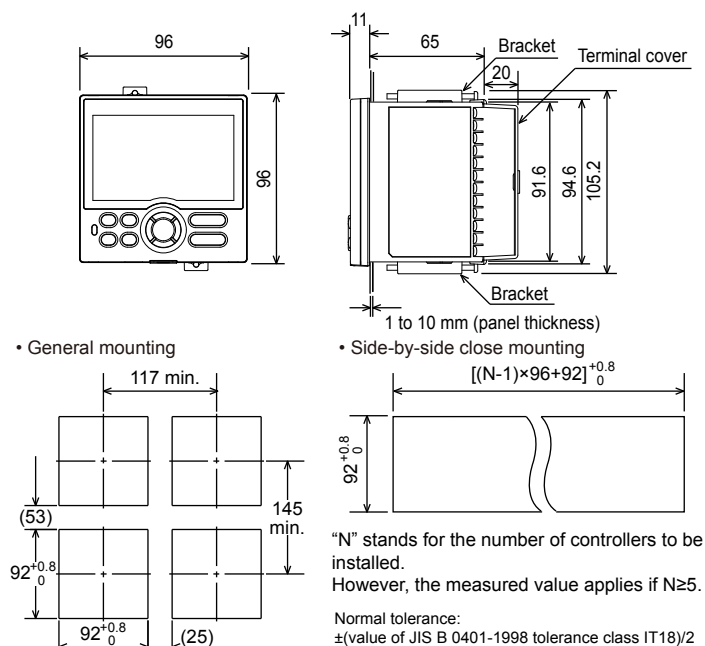

UT52A

Unit: mm

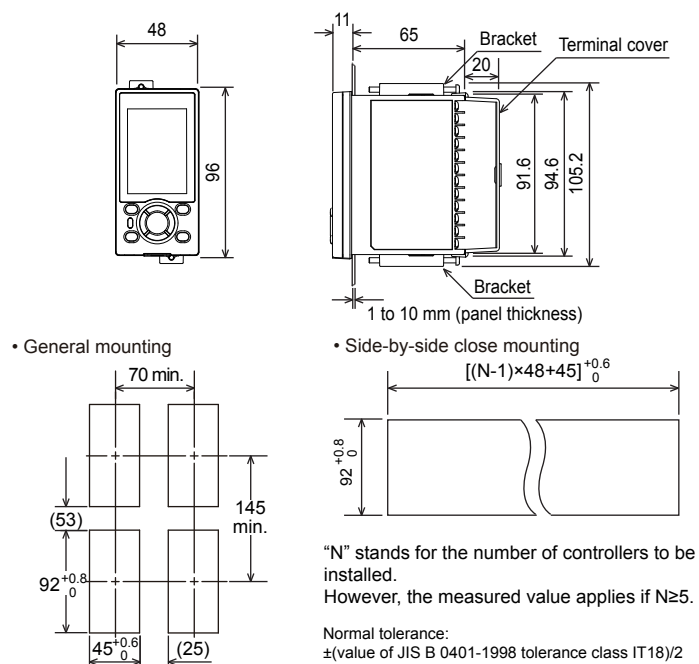

Construction, Mounting, and Wiring

- Dust-proof and drip-proof: IP66 (Front panel) (Except for side-by-side close mounting)/NEMA4 *
*: Hose-down test only
- Material: Polycarbonate resin (Flame retardancy: UL94 V-0)
- Case color: White (Light gray) or Black (Light Charcoal gray)
- Weight: 0.5 kg or less
- External dimensions (mm):
UT55A: 96 (width) x 96 (height) x 65 (depth from the panel surface)
UT52A: 48 (width) x 96 (height) x 65 (depth from the panel surface)

- Mounting: Direct panel mounting; mounting bracket, one each for upper and lower mounting
- Panel cutout dimensions (mm):
UT55A: $92^{+0.8/0}$ (width) x $92^{+0.8/0}$ (height)
UT52A: $45^{+0.6/0}$ (width) x $92^{+0.8/0}$ (height)
- Mounting position: Up to 30 degrees above the horizontal. No downward tilting allowed.
- Wiring: M3 screw terminal with square washer (signal wiring and power)

■ Model and Suffix Code

Model	Suffix code	Option code	Description
UT55A			Digital Indicating Controller (Power supply 100-240 V AC) (provided with retransmission output or 15 V DC loop power supply , 3 DIs, and 3 DOs)
Type 1: Basic control	-0 -1 -2		Standard type Position proportional type Heating/cooling type
Type 2: Functions	0		None
	1		Remote (1 additional aux. analog) input, 6 additional DIs, 5 additional DOs, and RS-485 communication (Max. 19.2 kbps, 2-wire/4-wire) ^{(*)1} ^{(*)2}
	2		Remote (1 additional aux. analog) input, 1 additional DI, and RS-485 communication (Max. 19.2 kbps, 2-wire/4-wire) ^{(*)2}
	3		5 additional DIs and 5 additional DOs
	4		Remote (1 additional aux. analog) input and 1 additional DI
	5		Remote (1 additional aux. analog) input, 6 additional DIs, and 5 additional DOs
	6		5 additional DIs, and 15 additional DOs ^{(*)1}
Type 3: Open networks	7		3 additional aux. analog inputs and 3 additional DIs
	0		None
	1		RS-485 communication (Max. 38.4 kbps, 2-wire/4-wire)
	2		Ethernet communication (with serial gateway function)
	3		CC-Link communication (with Modbus master function)
Display language ^{(*)3}	4		PROFIBUS-DP communication (with Modbus master function)
	5		DeviceNet communication (with Modbus master function)
	-1		English (Default. Can be switched to other language by the setting.)
	-2		German (Default. Can be switched to other language by the setting.)
Case color	-3		French (Default. Can be switched to other language by the setting.)
	-4		Spanish (Default. Can be switched to other language by the setting.)
Fixed code	0		White (Light gray)
	1		Black (Light charcoal gray)
Option codes		-00	Always "-00" (for Standard Code Model)
Option codes		/DR	Additional direct input (TC & 3-wire/4-wire RTD) and current to Remote (1 additional aux. analog) input, 1 DI to be deleted ^{(*)4}
		/LP	24 V DC loop power supply ^{(*)5}
		/HA	Heater break alarm ^{(*)6}
		/DC	Power supply 24 V AC/DC
		/CT	Coating ^{(*)7}
		/MDL	Mount on DIN rail (without the display parts and keys) (please see the General Specifications GS 05P01C81-01EN.)

*1: When the Type 2 code is "1" or "6", only "0" can be specified for the Type 3 code.

*2: When the /LP option is specified, the RS-485 communication of the Type 2 code "1" or "2" is 2-wire system.

*3: English, German, French, and Spanish are available for the guide display.

*4: The /DR option can be specified when the Type 2 code is any of "1", "2", "4", "5", or "7."

*5: The /LP option can be specified in the combination of Type 2 code (any of "0", "2", "3", or "4") and Type 3 code (any of "0" or "1"). Additionally the /LP option can be specified in the combination of Type 2 code "1" and Type 3 code "0".

*6: The /HA option can be specified only when the Type 1 code is "-0."

*7: When the /CT option is specified, the UT55A does not conform to the safety standards (UL and CSA) and CE marking (Products with /CT option are not intended for EEA-market).

Model	Suffix code	Option code	Description
UT52A			Digital Indicating Controller (Power supply 100-240 V AC) (provided with retransmission output or 15 V DC loop power supply , 3 DIs, and 3 DOs)
Type 1: Basic control	-0 -1 -2		Standard type Position proportional type Heating/cooling type
Type 2: Functions	0		None
	1		Remote (1 additional aux. analog) input, 1 additional DI, and RS-485 communication (Max. 38.4 kbps, 2-wire)
	2		Remote (1 additional aux. analog) input and 1 additional DI
Type 3: Open networks	3		2 additional DIs, and 2 additional DOs
	0		None
Display language ^{(*)2}	3		CC-Link communication (with Modbus master function) ^{(*)1}
	-1		English (Default. Can be switched to other language by the setting.)
	-2		German (Default. Can be switched to other language by the setting.)
	-3		French (Default. Can be switched to other language by the setting.)
Case color	-4		Spanish (Default. Can be switched to other language by the setting.)
	0		White (Light gray)
Fixed code	1		Black (Light charcoal gray)
		-00	Always "-00" (for Standard Code Model)
Option codes		/DR	Additional direct input (TC & 3-wire/4-wire RTD) and current to Remote (1 additional aux. analog) input, 1 DI to be deleted ^{(*)3}
		/LP	24 V DC loop power supply ^{(*)4}
		/HA	Heater break alarm ^{(*)5}
		/DC	Power supply 24 V AC/DC
		/CT	Coating ^{(*)6}
		/MDL	Mount on DIN rail (without the display parts and keys) (please see the General Specifications GS 05P01C81-01EN.)

*1: The Type 3 code "3" can be specified only when the Type 1 code is "-0" and the Type 2 code is "0."

*2: English, German, French, and Spanish are available for the guide display.

*3: The /DR option can be specified only when the Type 2 code is "2" and the Type 3 code is "0."

*4: The /LP option can be specified only when the Type 1 code is "-0" or "-1." Furthermore both Type 2 and Type 3 codes should be "0."

*5: The /HA option can be specified only when the Type 1 code is "-0" and the Type 3 code is "0."

*6: When the /CT option is specified, the UT52A does not conform to the safety standards (UL and CSA) and CE marking (Products with /CT option are not intended for EEA-market).

■ Items to be specified when ordering

Model and suffix codes, whether User's Manual and QIC required.

■ Standard accessories

Terminal cover, Brackets (mounting hardware), Unit label, and Operation Guide for Single-loop Control.

■ Special Order Items

Model code	Suffix code	Description
LL50A	-00	Parameter Setting Software
X010	See the General Specifications (*)	Resistance Module

*: Necessary to input the current signal to the voltage input terminal.

Name	Model
Terminal cover (for UT55A)	UTAP001
Terminal cover (for UT52A)	UTAP002
User's Manual (CD)	UTAP003

User's Manual

Product user's manuals can be downloaded or viewed at the following URL. To view the user's manual, you need to use Adobe Reader 7 or later by Adobe Systems.

URL: <http://www.yokogawa.com/ns/ut/im/>